

V. PATTERN DIAGRAM

1. PARTS ARRANGEMENT FOR EACH PCB ASS'Y

1) MAIN_TOP

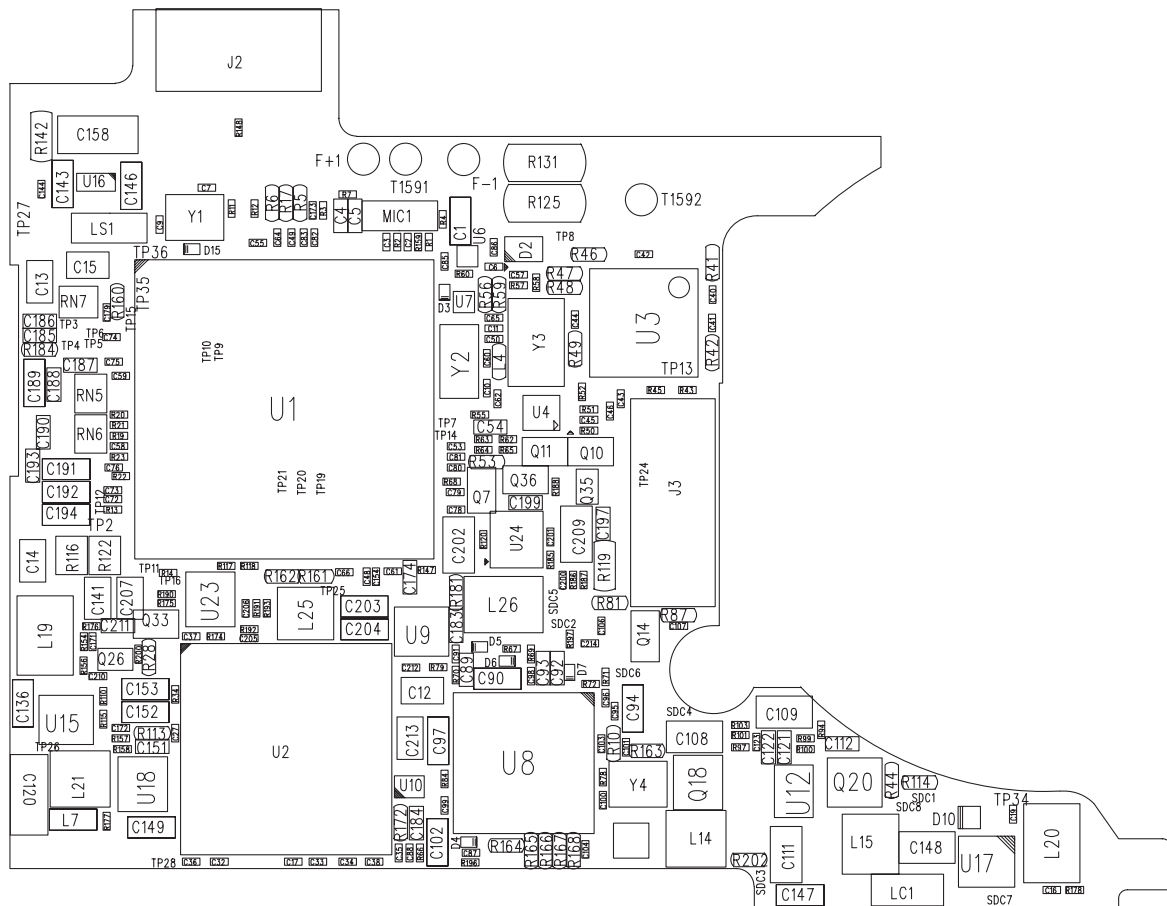

2) MAIN_BOTTOM

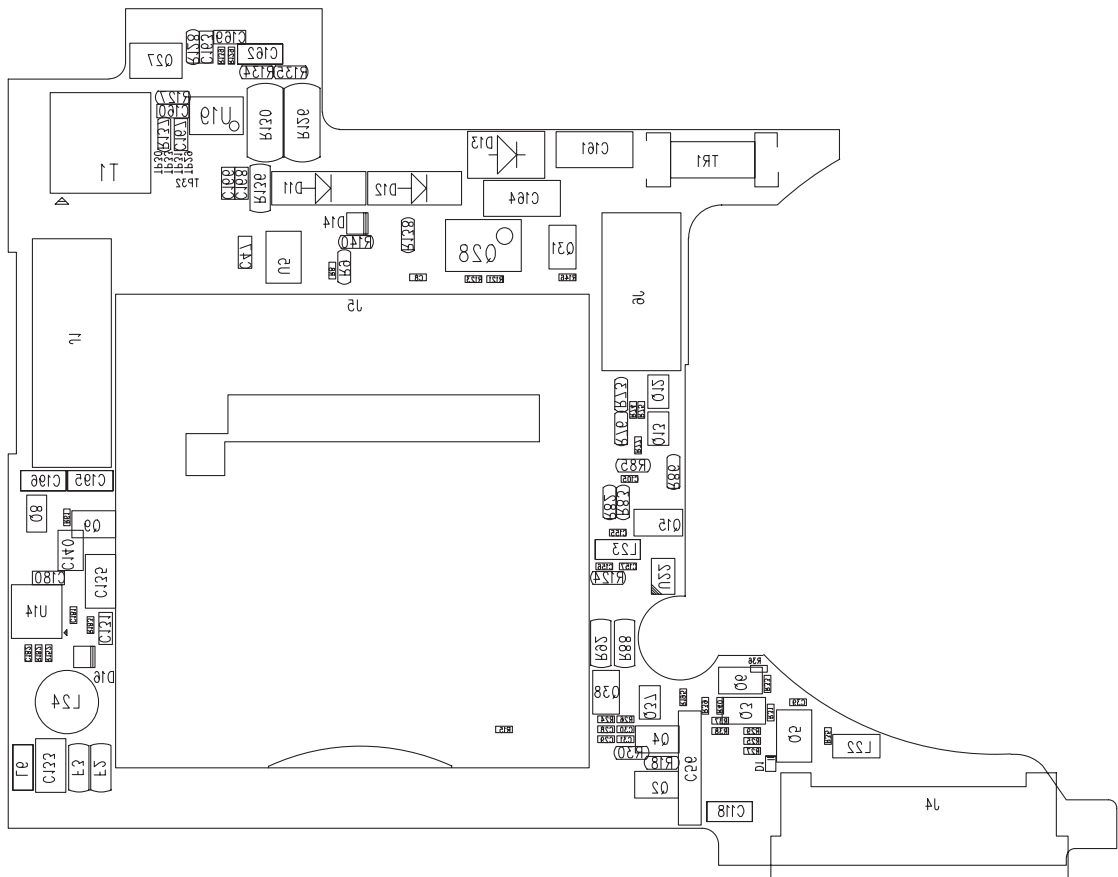

V. PATTERN DIAGRAM

3) CCD_FPC

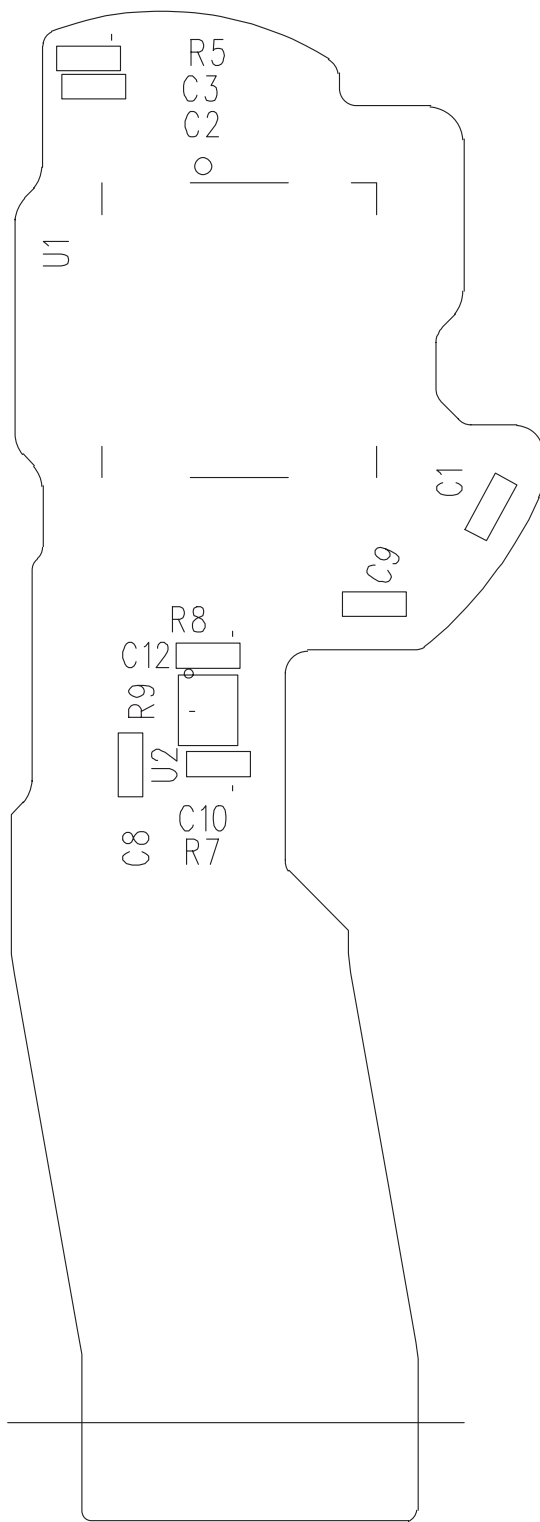

V. PATTERN DIAGRAM

5) UI_FPC

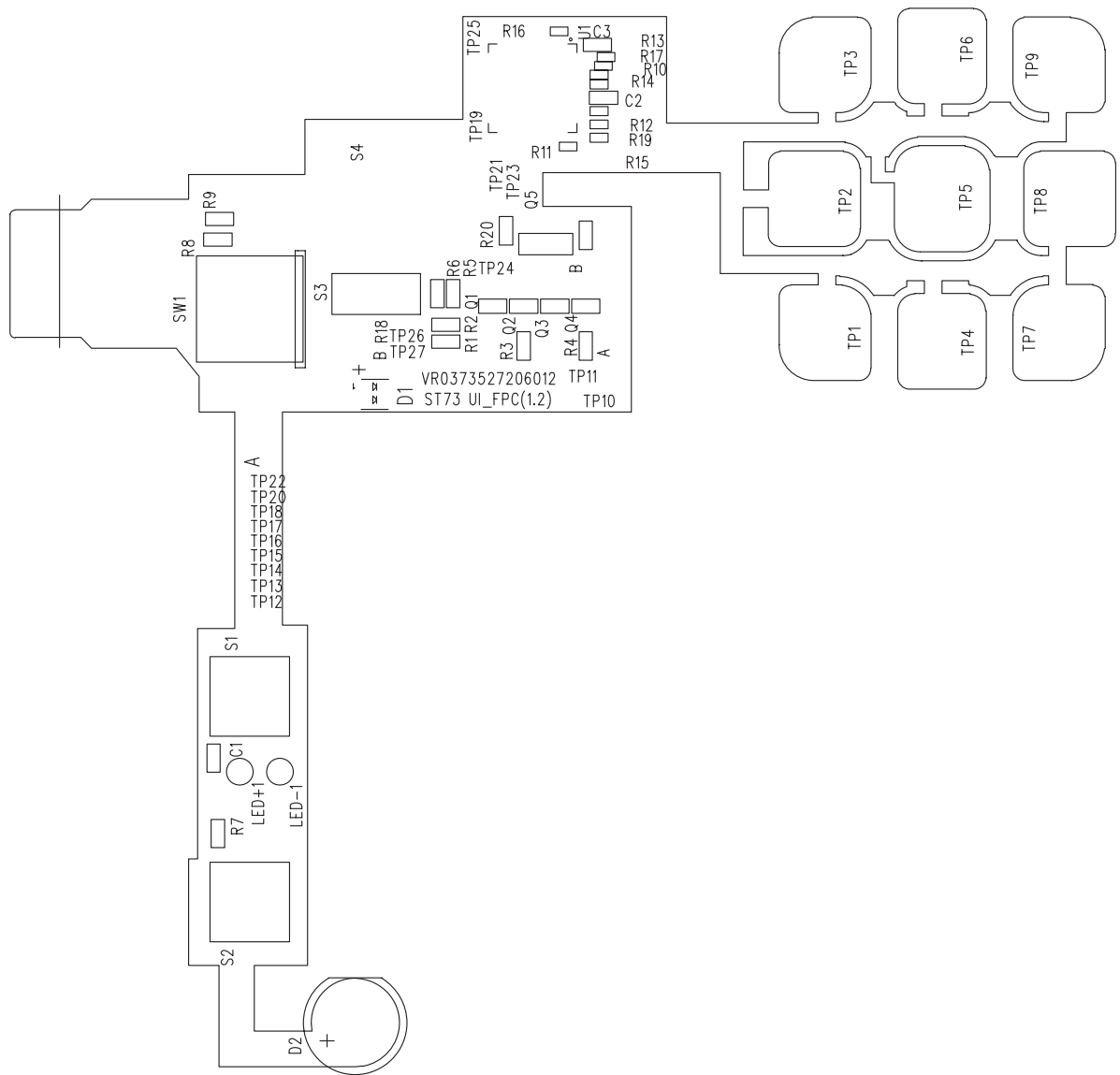

1) MAIN_BUTTON INTERFACE,AUDIO,USB,UART,SPK,X'TAL,ADC AND EJTAG

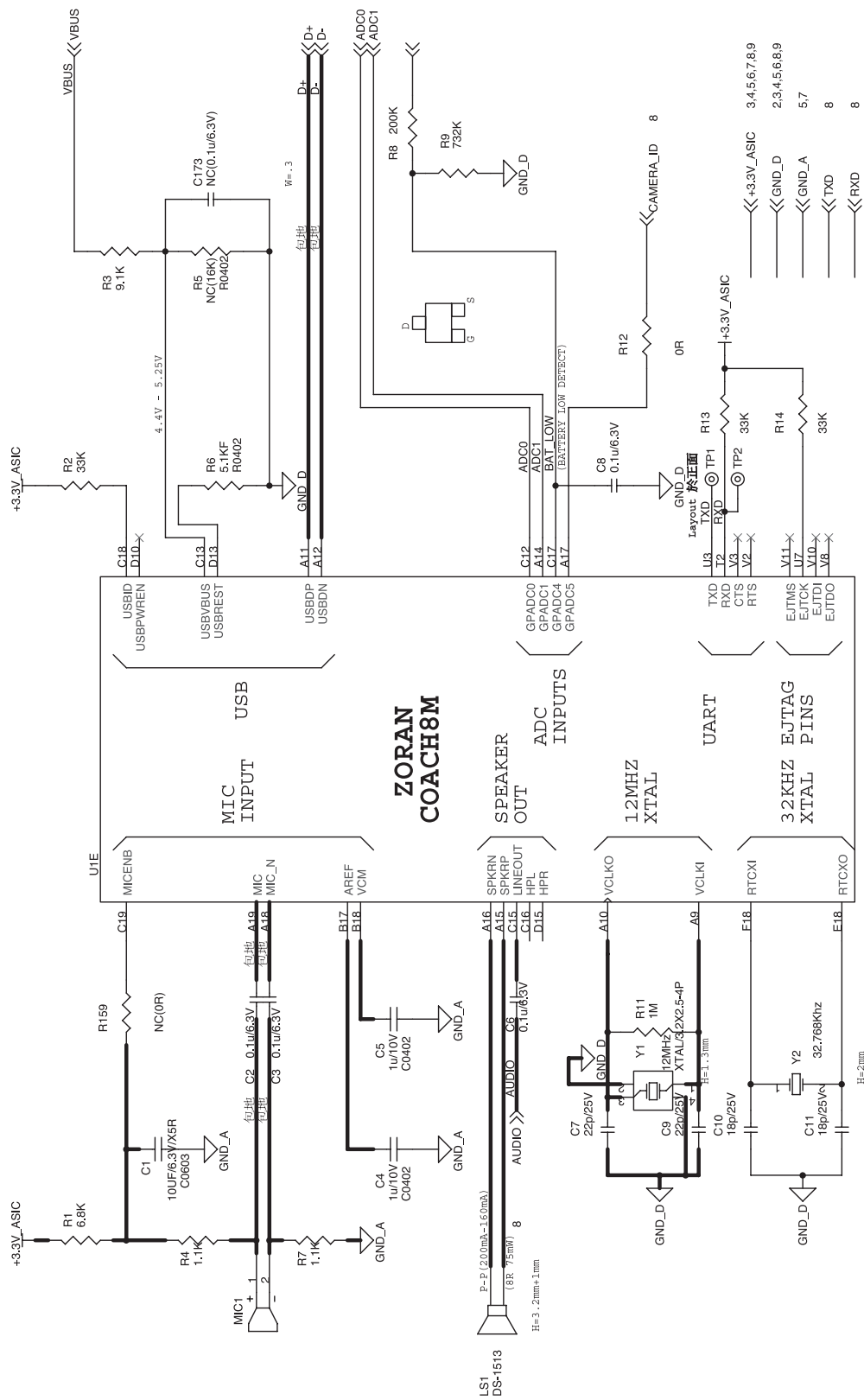

VI. CIRCUIT DIAGRAM

2) MAIN_LCD INTERFACE AND VIDEO OUT

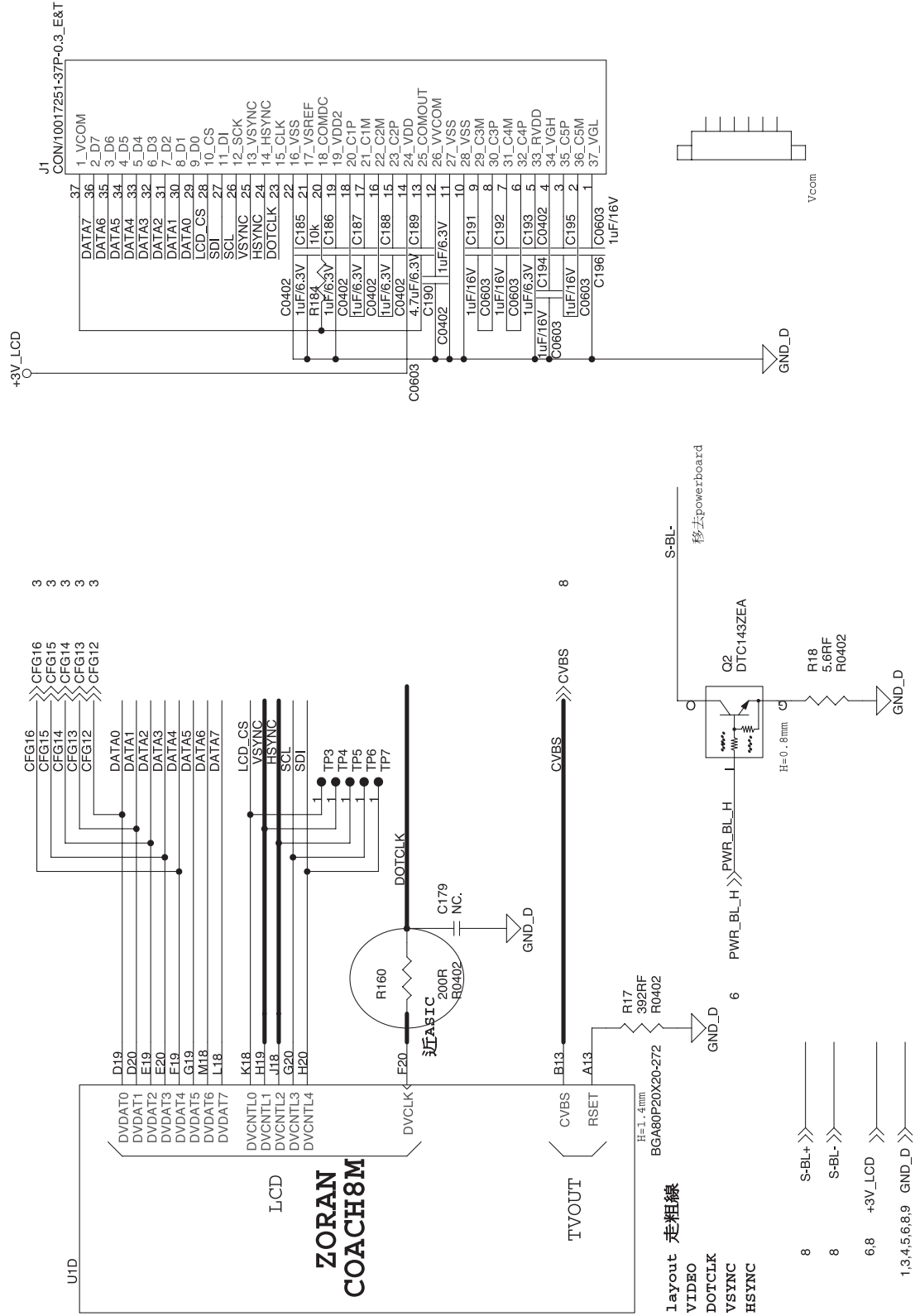

3) MAIN_DRAM,NAND,SD INTERFACE AND CONFIGURATION RESISTORS

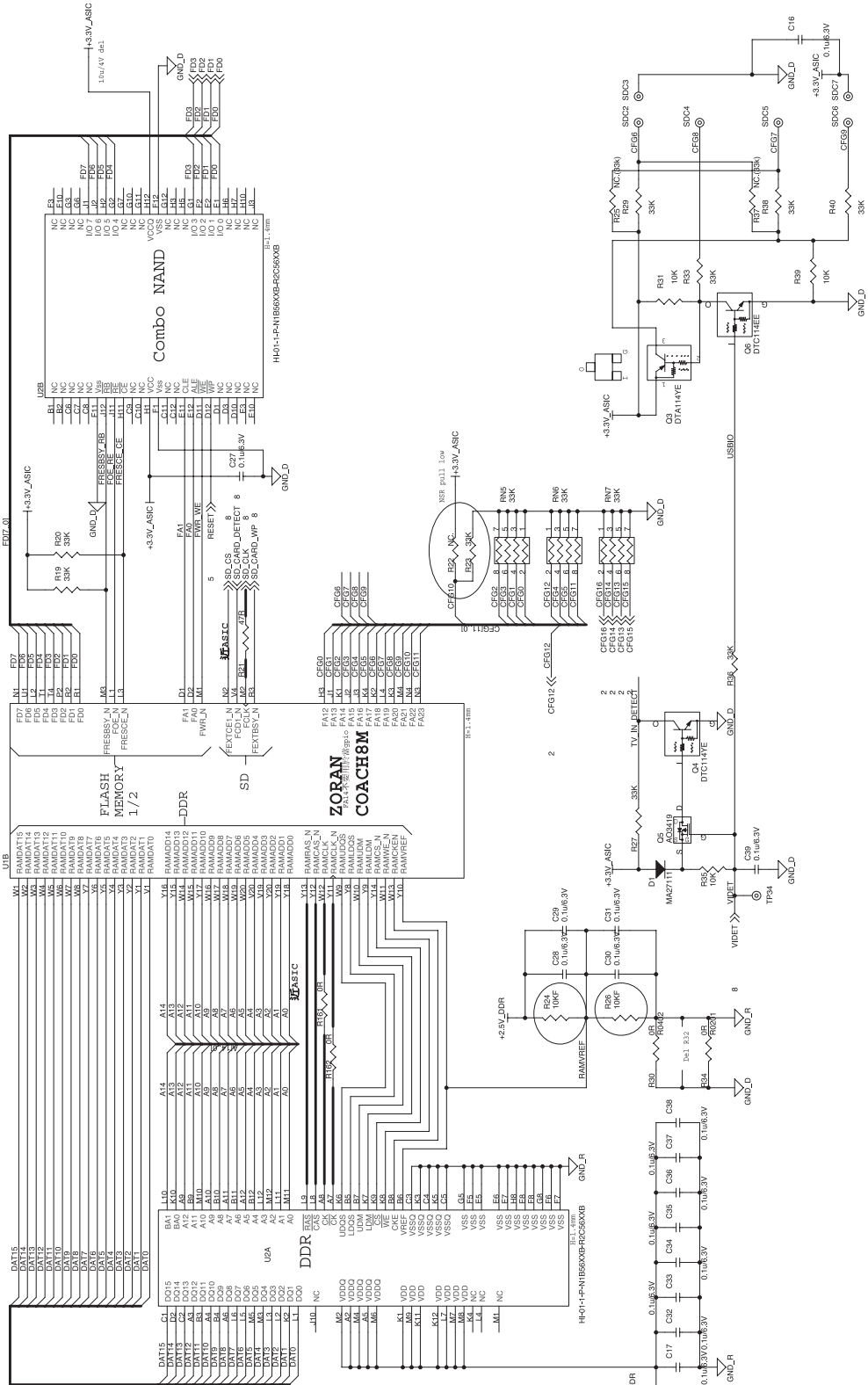

4) MAIN_MOTOR INTERFACE

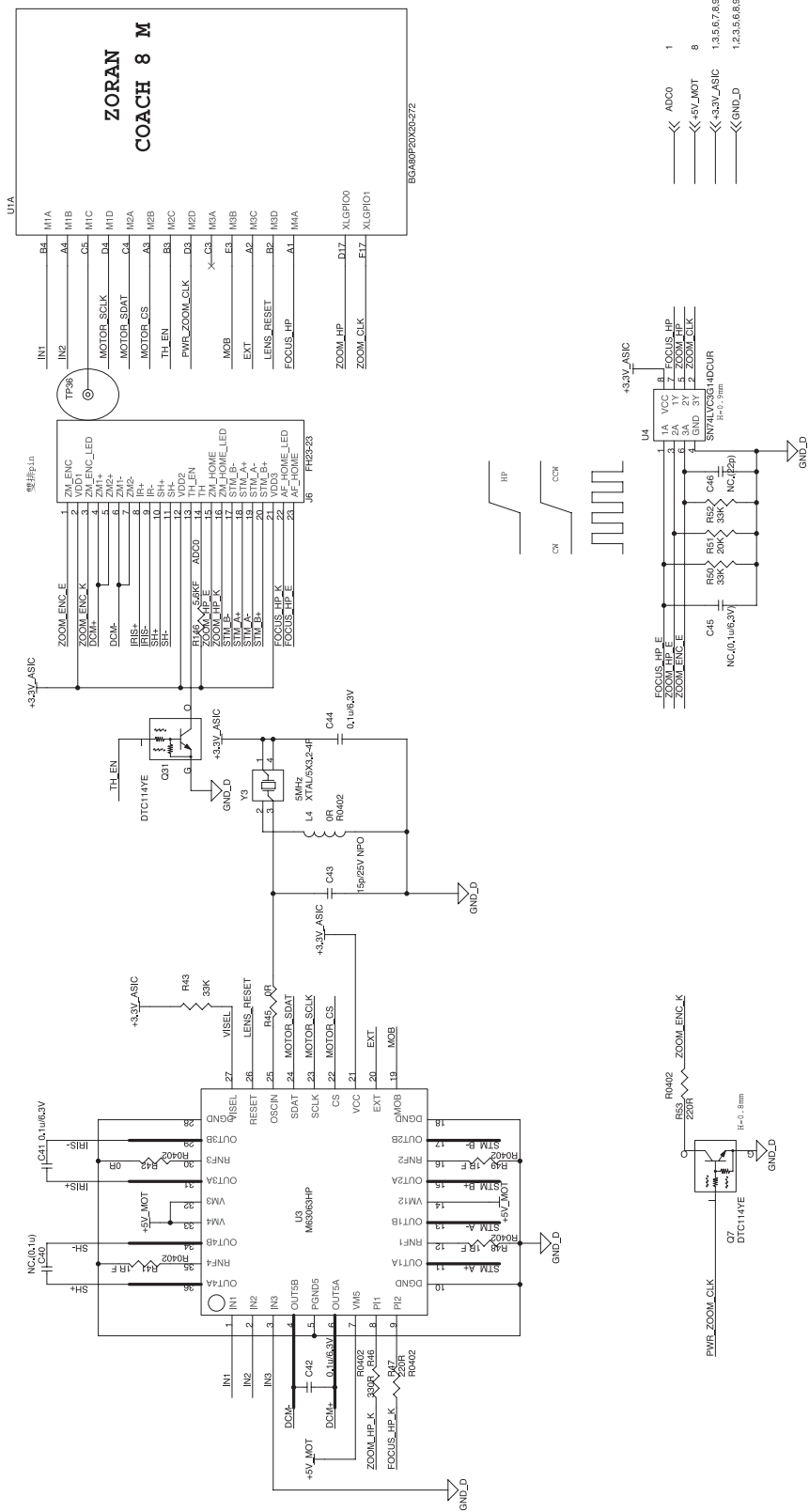

5) MAIN_POWER AND RESET

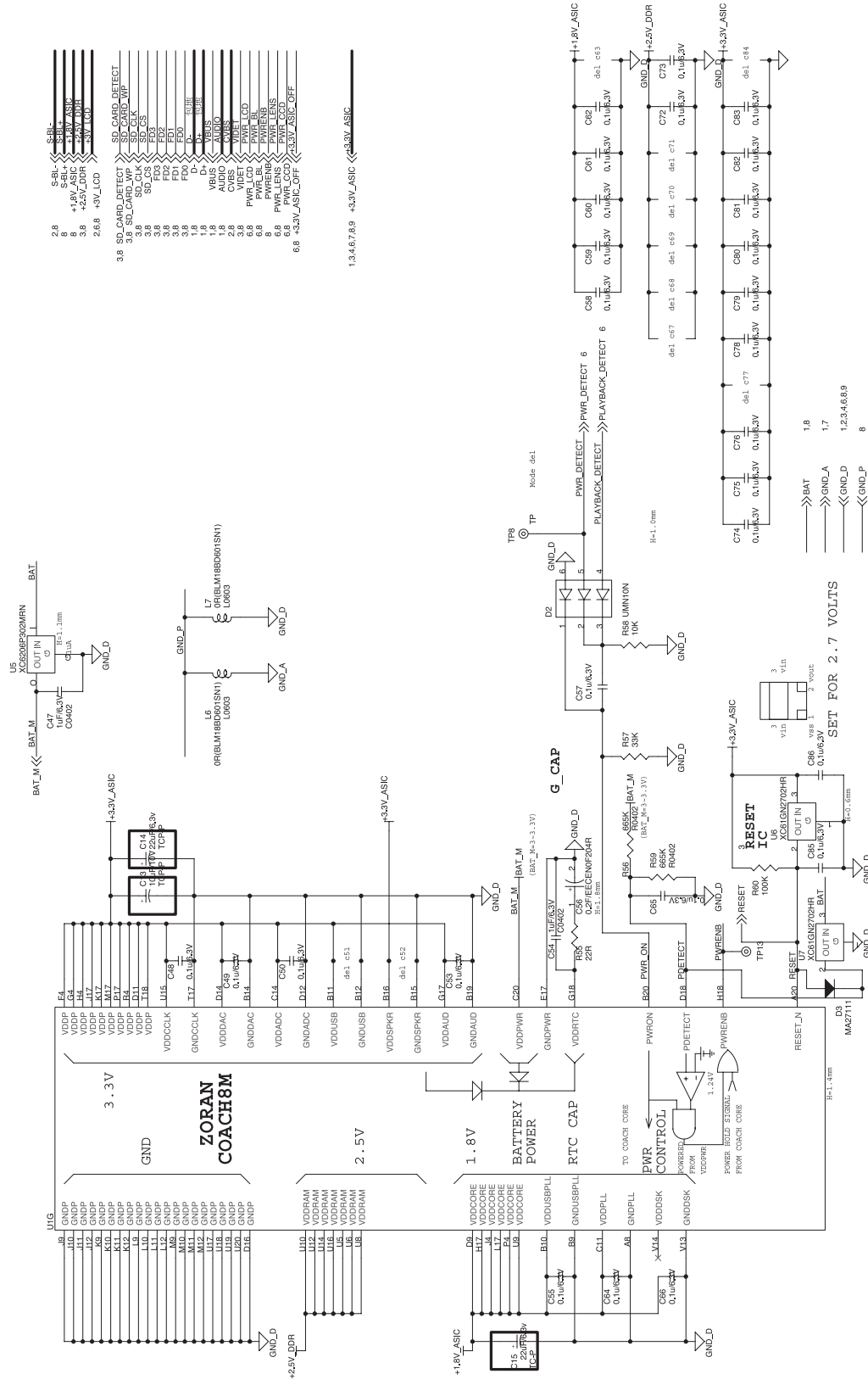

VI. CIRCUIT DIAGRAM

6) MAIN_STROBE,GPIO AND PWM

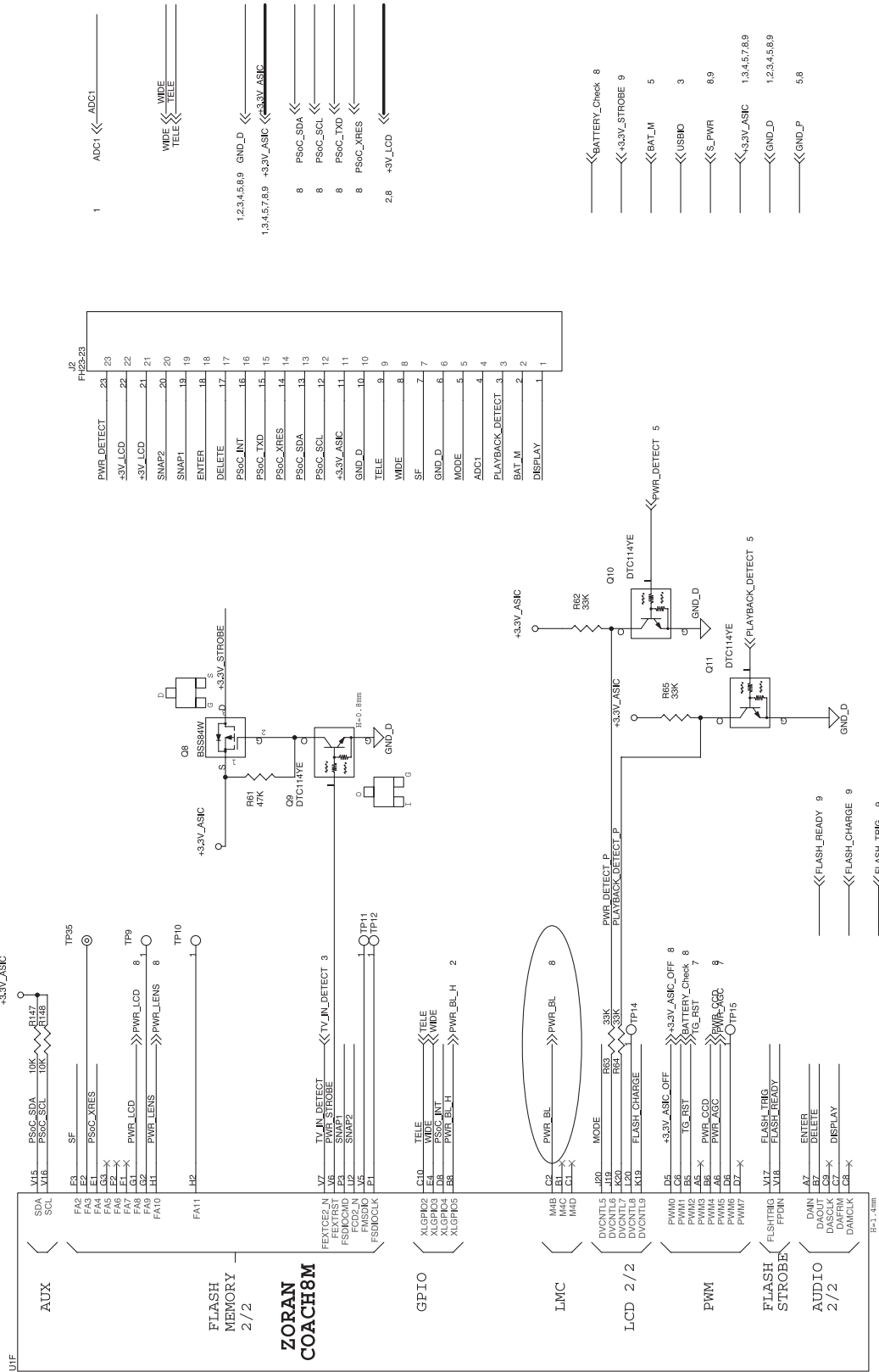

7) MAIN_SENSOR INTERFACE for SONY

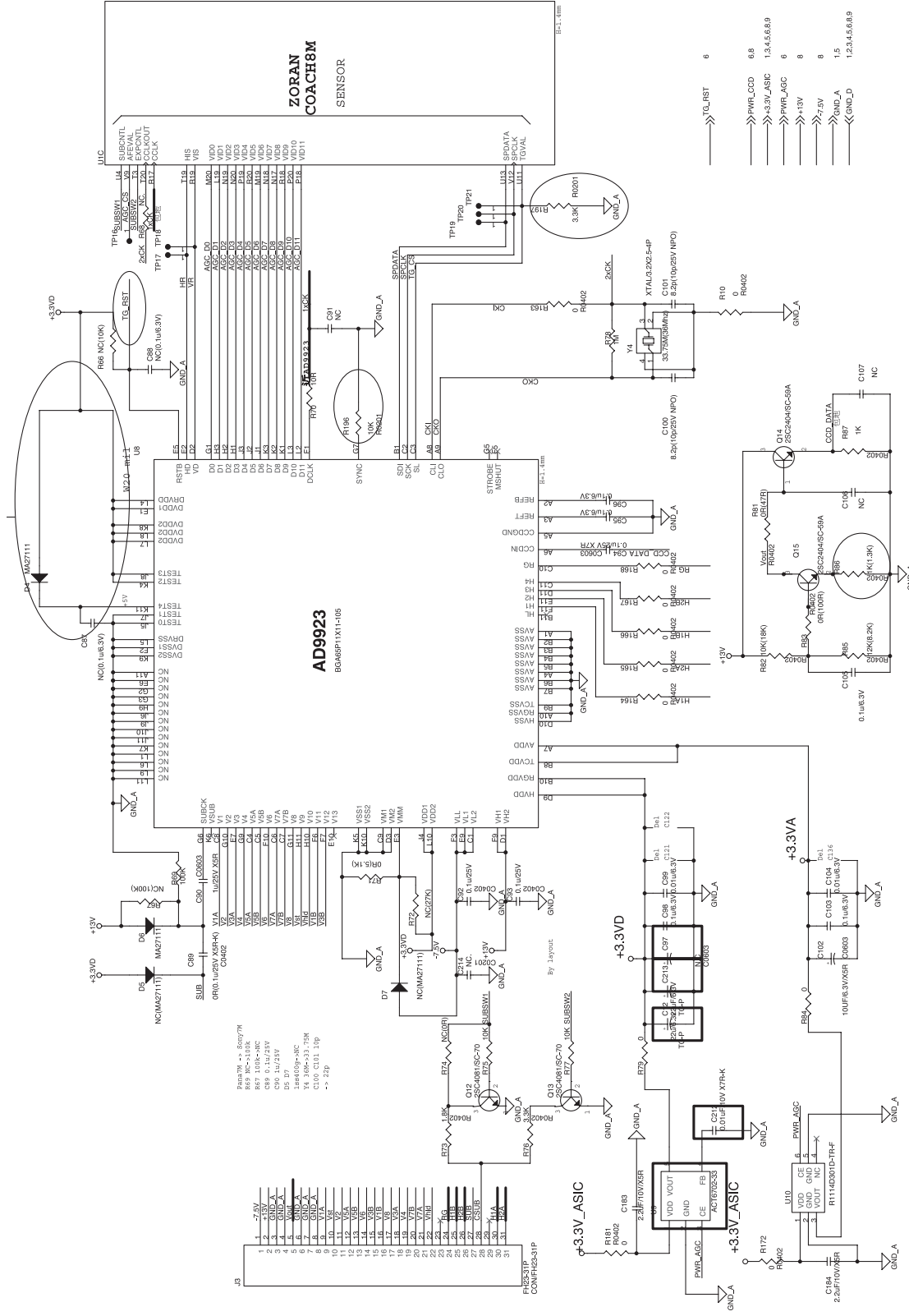

VI. CIRCUIT DIAGRAM

8) POWER

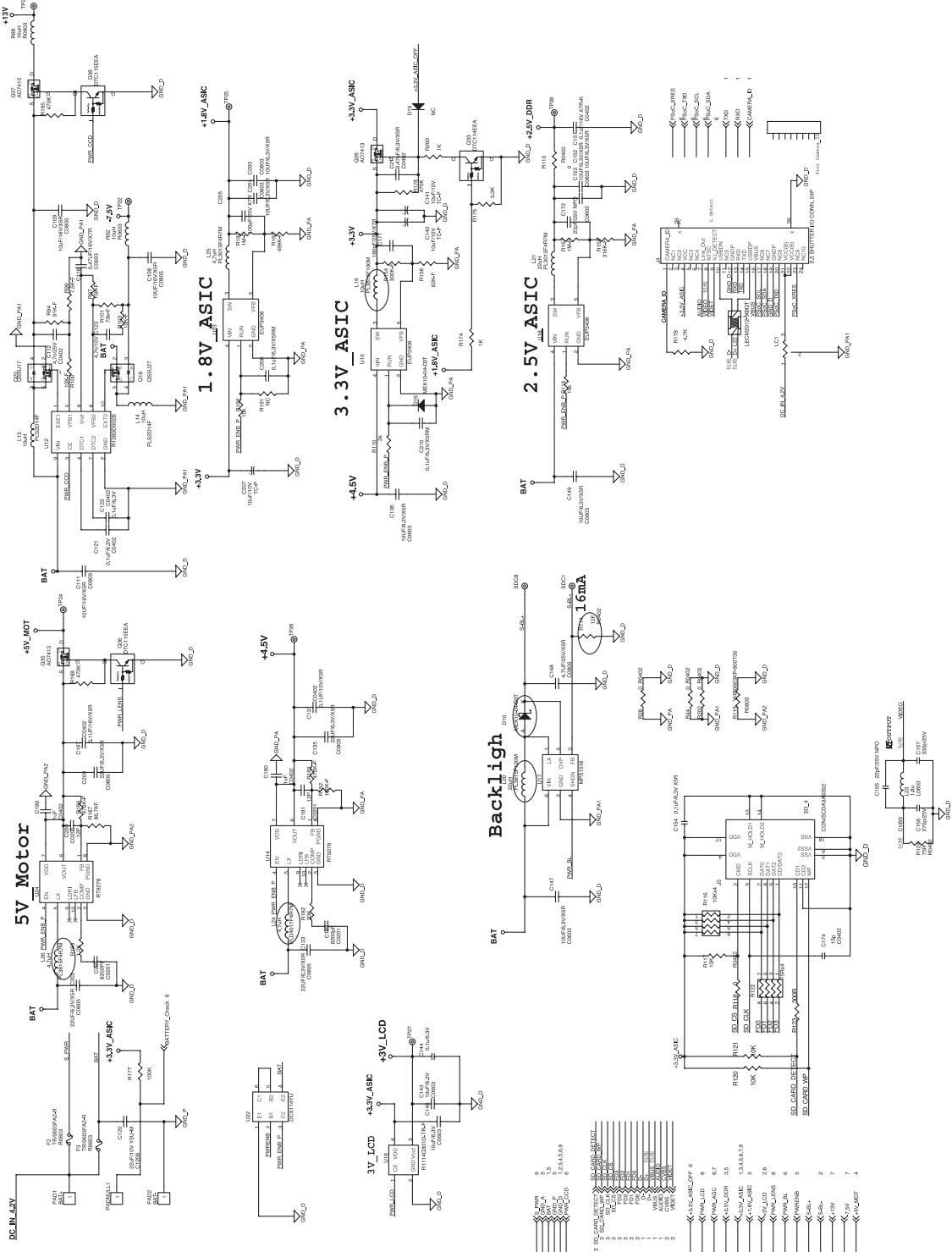

9) STROBO

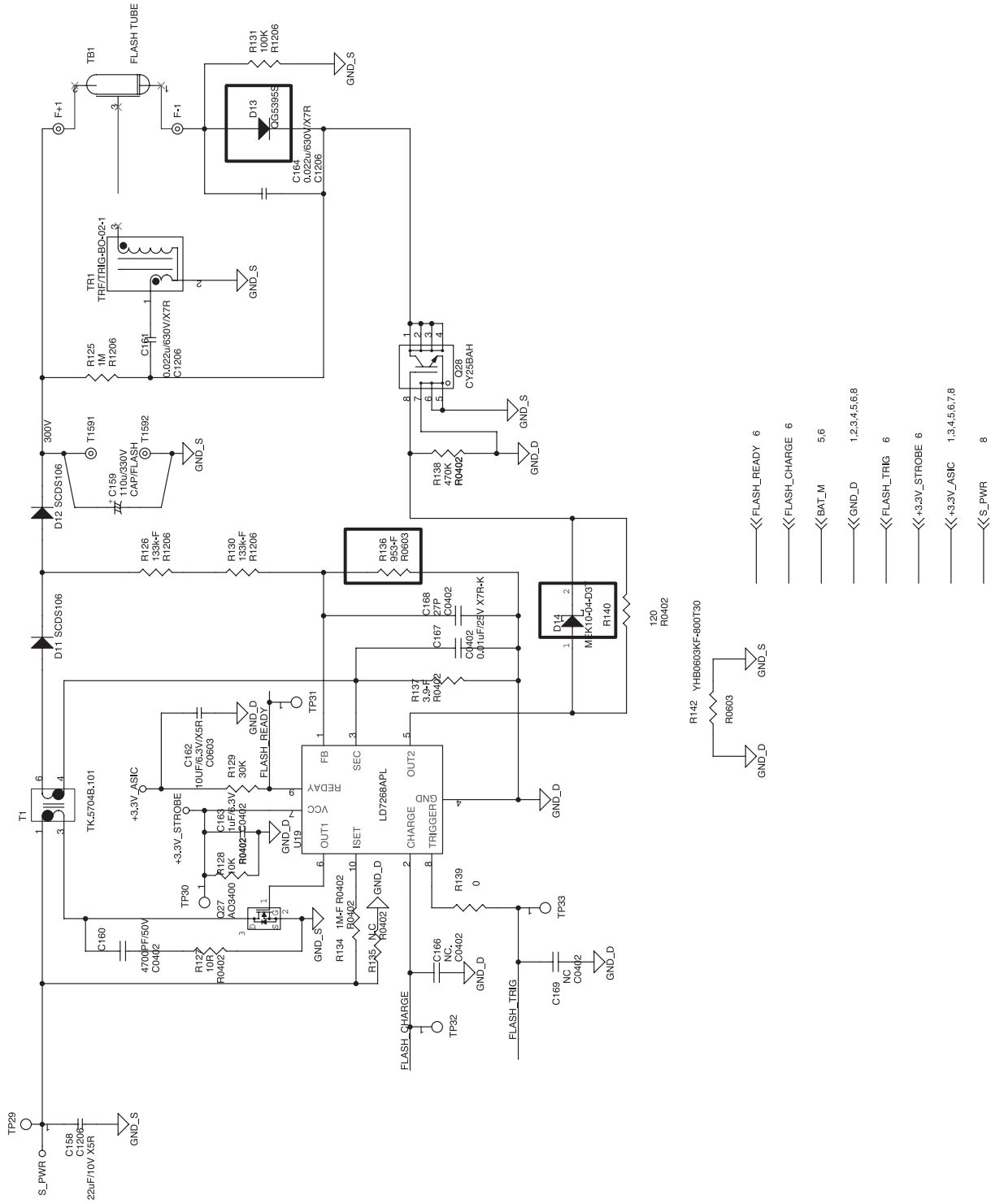

VI. CIRCUIT DIAGRAM

10) CCD

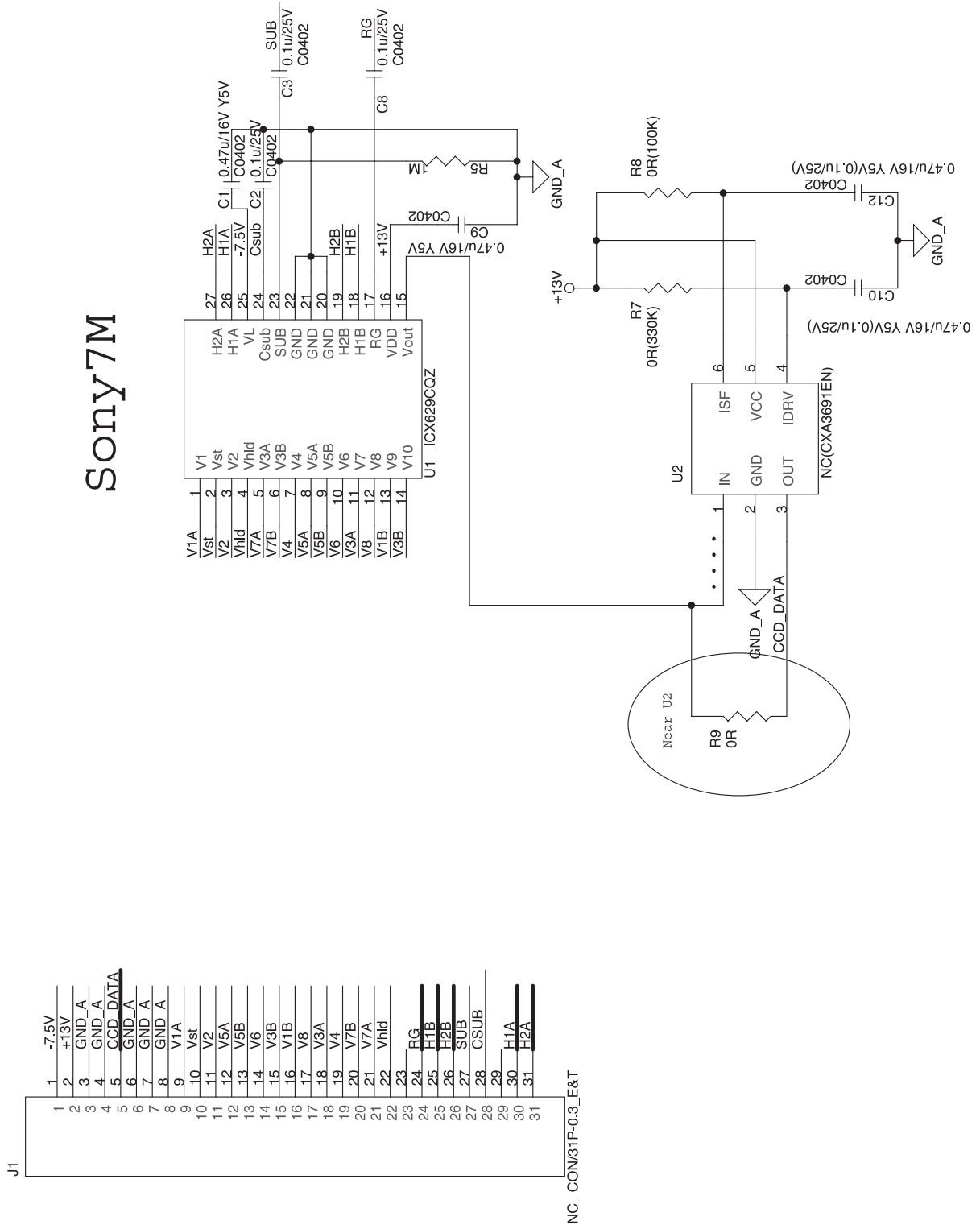

11) UI_BUTTON

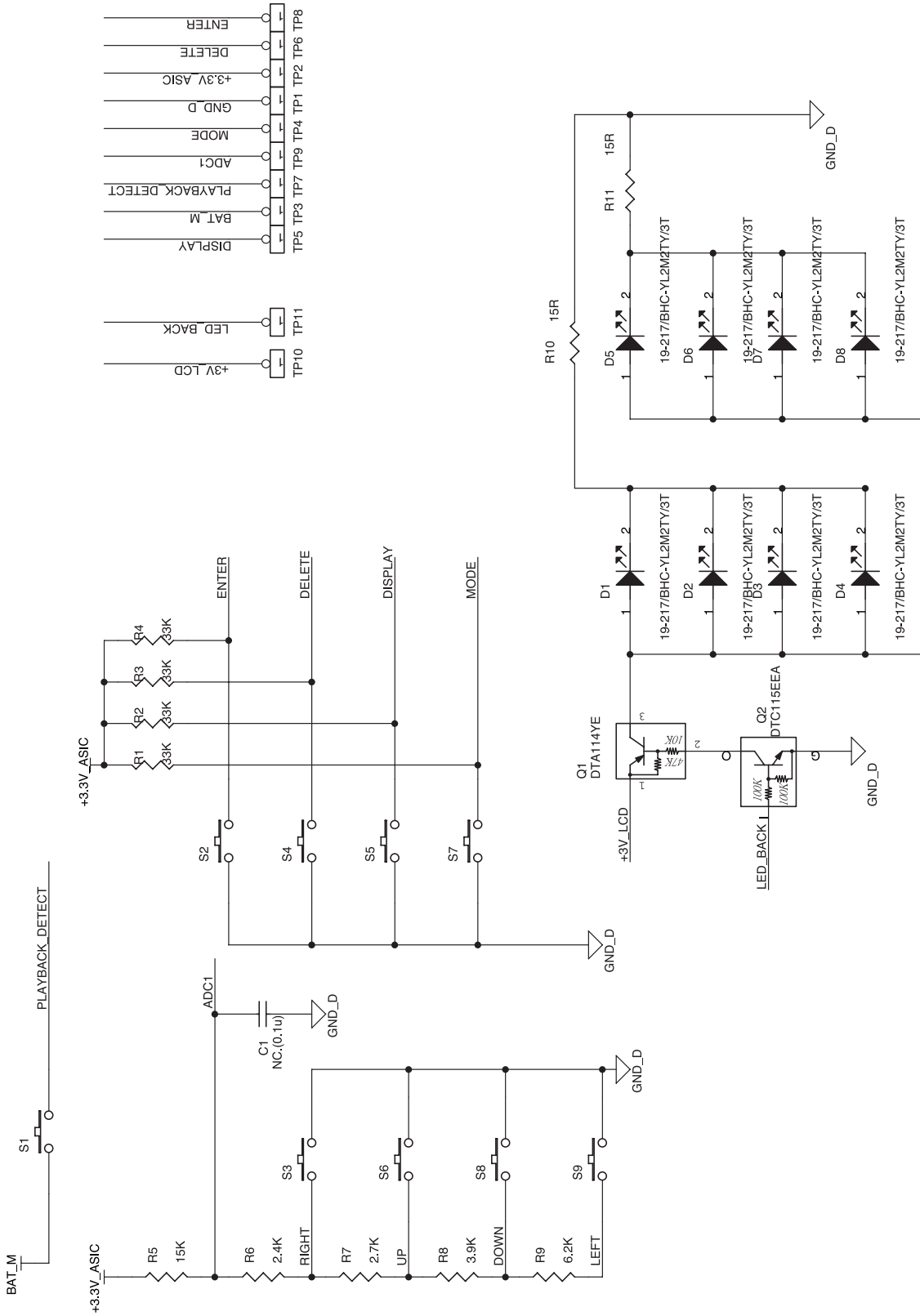

VI. CIRCUIT DIAGRAM

12) UI_FPC

